

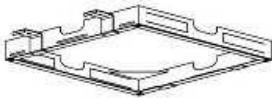

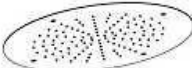





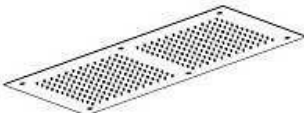

# E044047B



	<b>E044048</b>	<b>E044047</b>	<b>E044046</b>	<b>E044024</b>	<b>E044067</b>	<b>E044096</b>	<b>E044088</b>	<b>E044059</b>
	X1	X1	X1	X1	X1	X1	X1	X1
	X1	X1	-	-	-	-	-	-
	-	-	X1	X1	X1	-	-	-
	-	-	-	-	-	X1	-	-
	-	-	-	-	-	-	X1	X1
	X2	X2	X2	X2	X4	X2	X2	X2
	X1	X1	X1	X1	X2	X1	X1	X1
	X4	X4	X4	X4	X9	X4	X6	X6
	-	-	-	-	X1	-	-	-
 <b>Montážní návod</b>	X1	X1	X1	X1	X1	X1	X1	X1

- Tento spotřebič musí být správně nainstalován odbornou firmou v souladu s platnými zákony.
- Případná oprava musí být provedena pouze odbornou firmou.

Výrobce odmítá jakoukoli odpovědnost v případě nedodržení výše uvedené povinnosti

# E044048

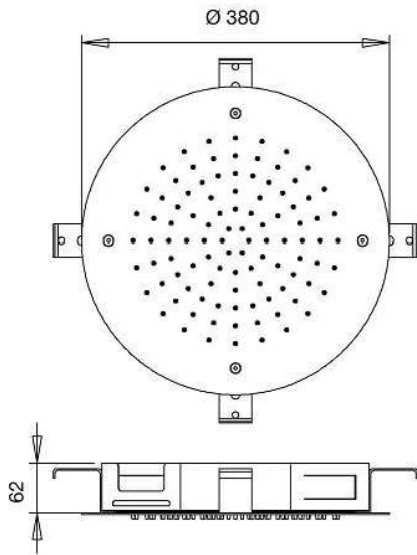

Průtok sprchy L/min



Minimum 1 Bar  
Maximum 5 Bar  
Optimum 3 Bar

Maximální 70°C  
Optimální 38°/40°C

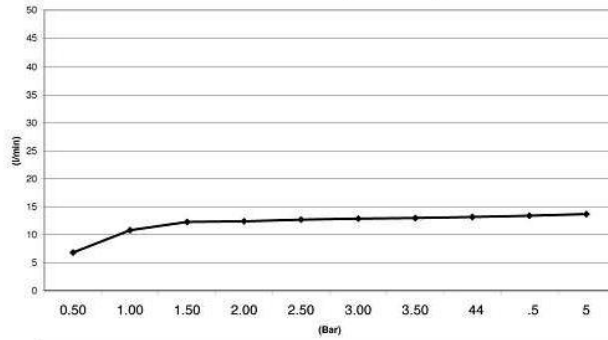

	Pressione Dinamica (bar) / Portata (Litri/min)									
Bar	0,50	1,00	1,50	2,00	2,50	3,00	3,50	4	4,5	5
—◆—	6,8	10,8	12,3	12,4	12,7	12,9	13	13,2	13,4	13,7

# E044047

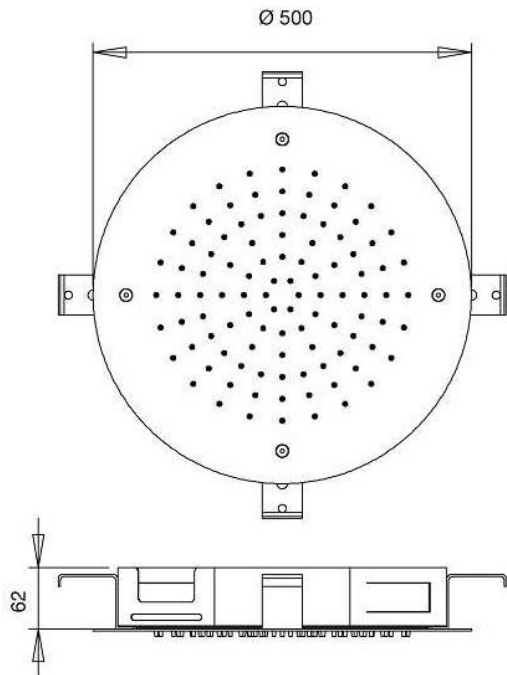

Průtok sprchy L/min



Minimum 1 Bar  
Maximum 5 Bar  
Optimum 3 Bar

Maximální 70°C  
Optimální 38°/40°C

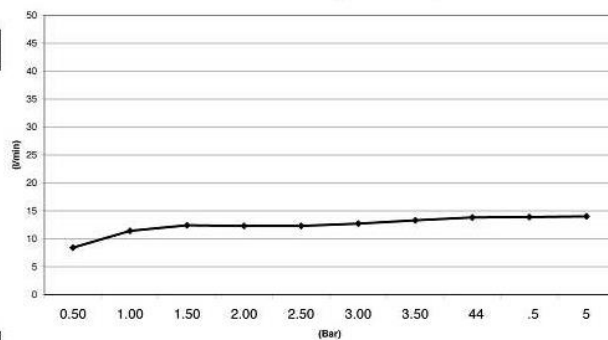

	Pressione Dinamica (bar) / Portata (Litri/min)									
Bar	0,50	1,00	1,50	2,00	2,50	3,00	3,50	4	4,5	5
—◆—	8,4	11,4	12,4	12,3	12,3	12,7	13,3	13,8	13,9	14

# E044046

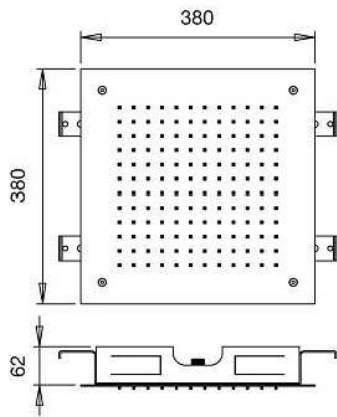

Průtok sprchy L/min



Minimum 1 Bar  
Maximum 5 Bar  
Optimum 3 Bar



Maximální 70°C  
Optimální 38°/40°C

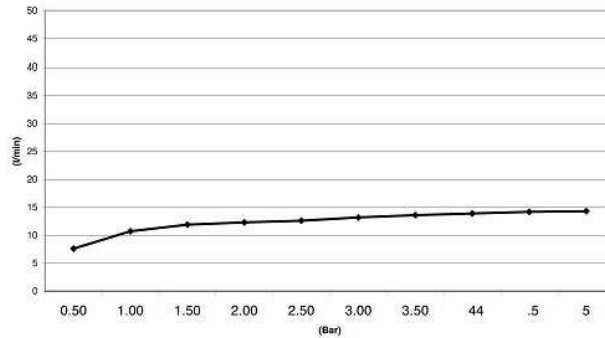

	Pressione Dinamica (bar) / Portata (Litri/min)									
Bar	0,50	1,00	1,50	2,00	2,50	3,00	3,50	4	4,5	5
—●—	7,6	10,7	11,9	12,3	12,6	13,2	13,6	13,9	14,2	14,3

# E044024

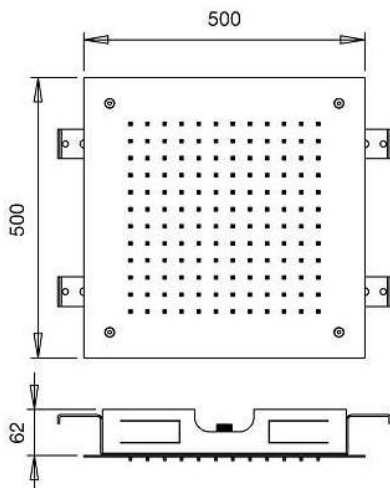

Průtok sprchy L/min



Minimum 1 Bar  
Maximum 5 Bar  
Optimum 3 Bar



Maximální 70°C  
Optimální 38°/40°C

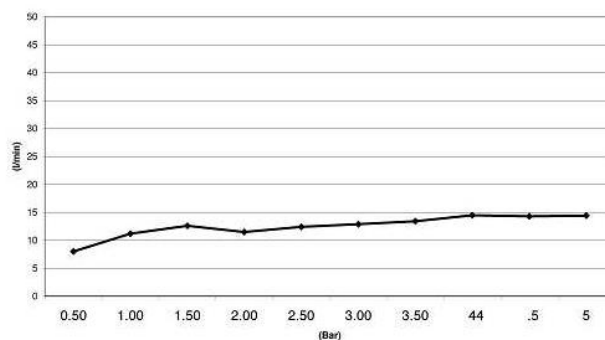

	Pressione Dinamica (bar) / Portata (Litri/min)									
Bar	0,50	1,00	1,50	2,00	2,50	3,00	3,50	4	4,5	5
—●—	8	11,2	12,6	11,5	12,4	12,9	13,4	14,5	14,3	14,4

# | E044067 |

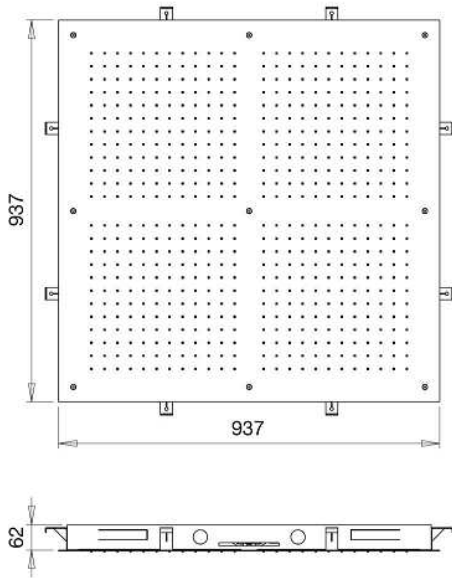

Průtok sprchy L/min



Minimum 1 Bar  
Maximum 5 Bar  
Optimum 3 Bar

Maximální 70°C  
Optimální 38°/40°C

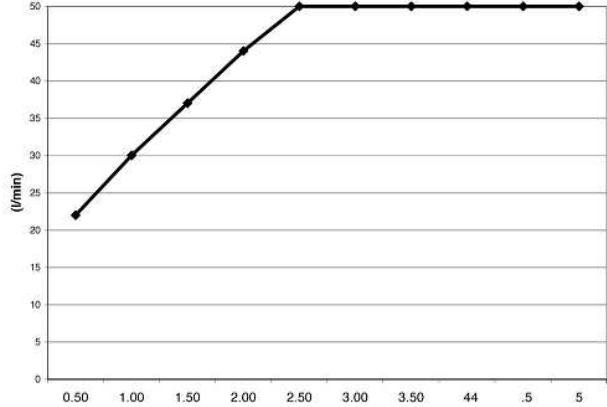

Bar	Pressione Dinamica (bar) / Portata (Litri/min)									
	0,50	1,00	1,50	2,00	2,50	3,00	3,50	4	4,5	5
●	22	30	37	44	50	50	50	50	50	50

# | E044096 |

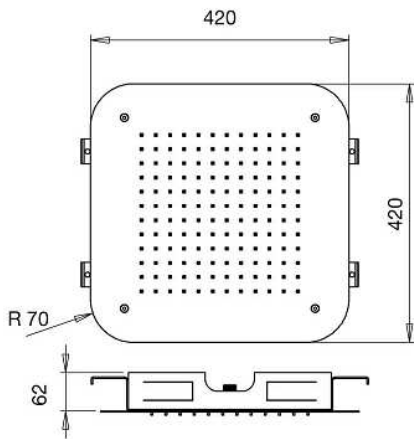

Průtok sprchy L/min



Minimum 1 Bar  
Maximum 5 Bar  
Optimum 3 Bar

Maximální 70°C  
Optimální 38°/40°C

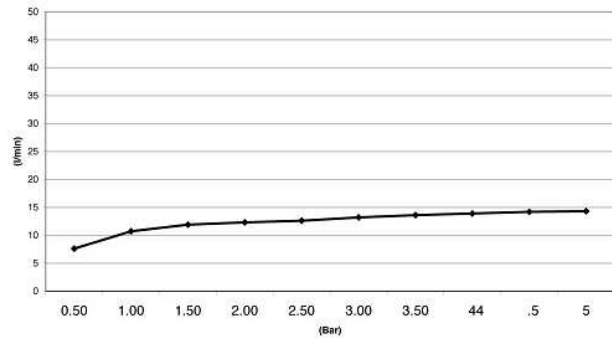

Bar	Pressione Dinamica (bar) / Portata (Litri/min)									
	0,50	1,00	1,50	2,00	2,50	3,00	3,50	4	4,5	5
●	7,6	10,7	11,9	12,3	12,6	13,2	13,6	13,9	14,2	14,3

# E044088

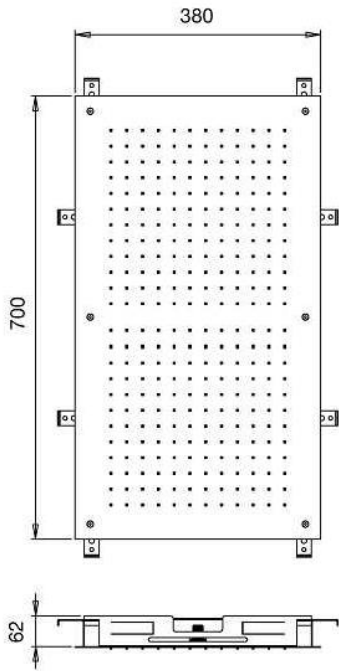

Průtok sprchy L/min



Minimum 1 Bar  
Maximum 5 Bar  
Optimum 3 Bar

Maximální 70°C  
Optimální 38°/40°C

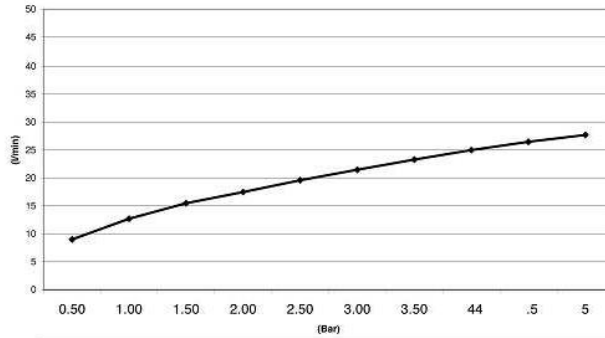

Bar	0,50	1,00	1,50	2,00	2,50	3,00	3,50	4	4,5	5
Průtok (l/min)	9	12,7	15,5	17,5	19,6	21,5	23,3	25	26,5	27,7

# E044059

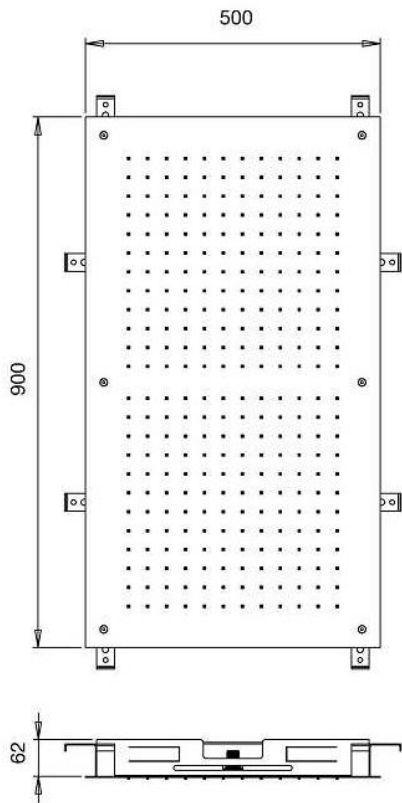

Průtok sprchy L/min



Minimum 1 Bar  
Maximum 5 Bar  
Optimum 3 Bar

Maximální 70°C  
Optimální 38°/40°C

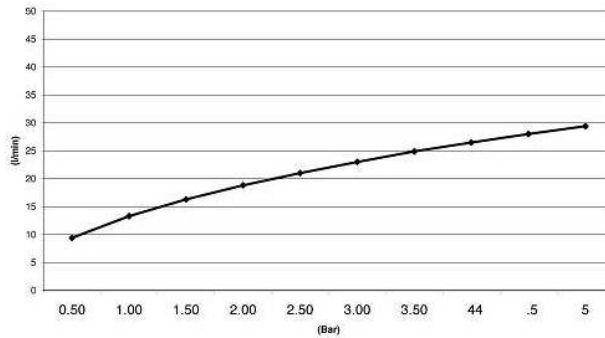

Bar	0,50	1,00	1,50	2,00	2,50	3,00	3,50	4	4,5	5
Průtok (l/min)	9,4	13,3	16,3	18,8	21	23	24,9	26,5	28	29,4

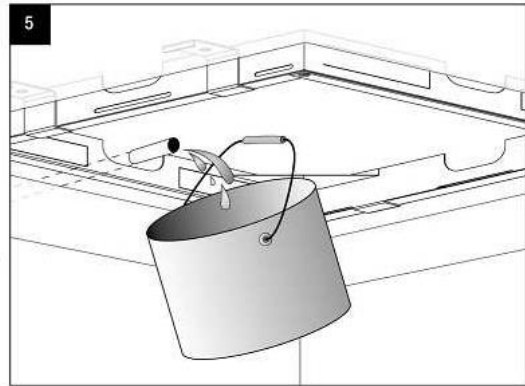
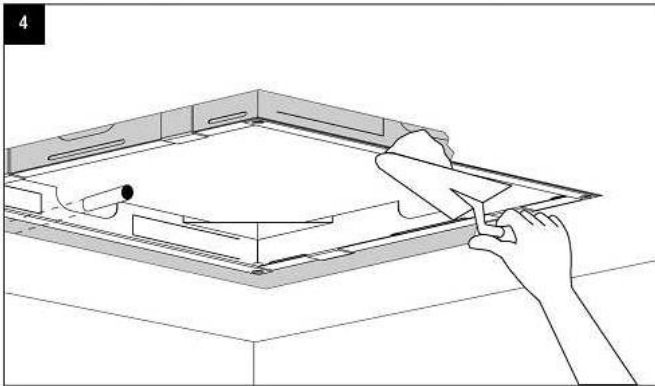
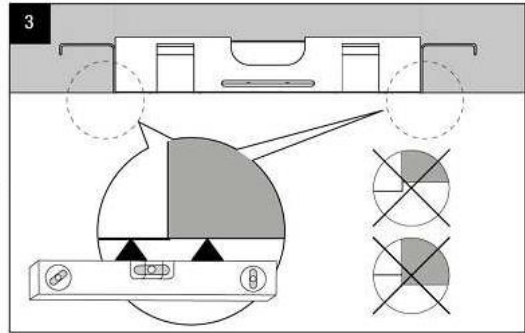
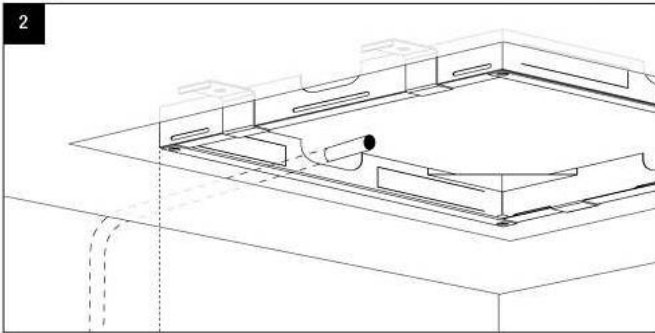
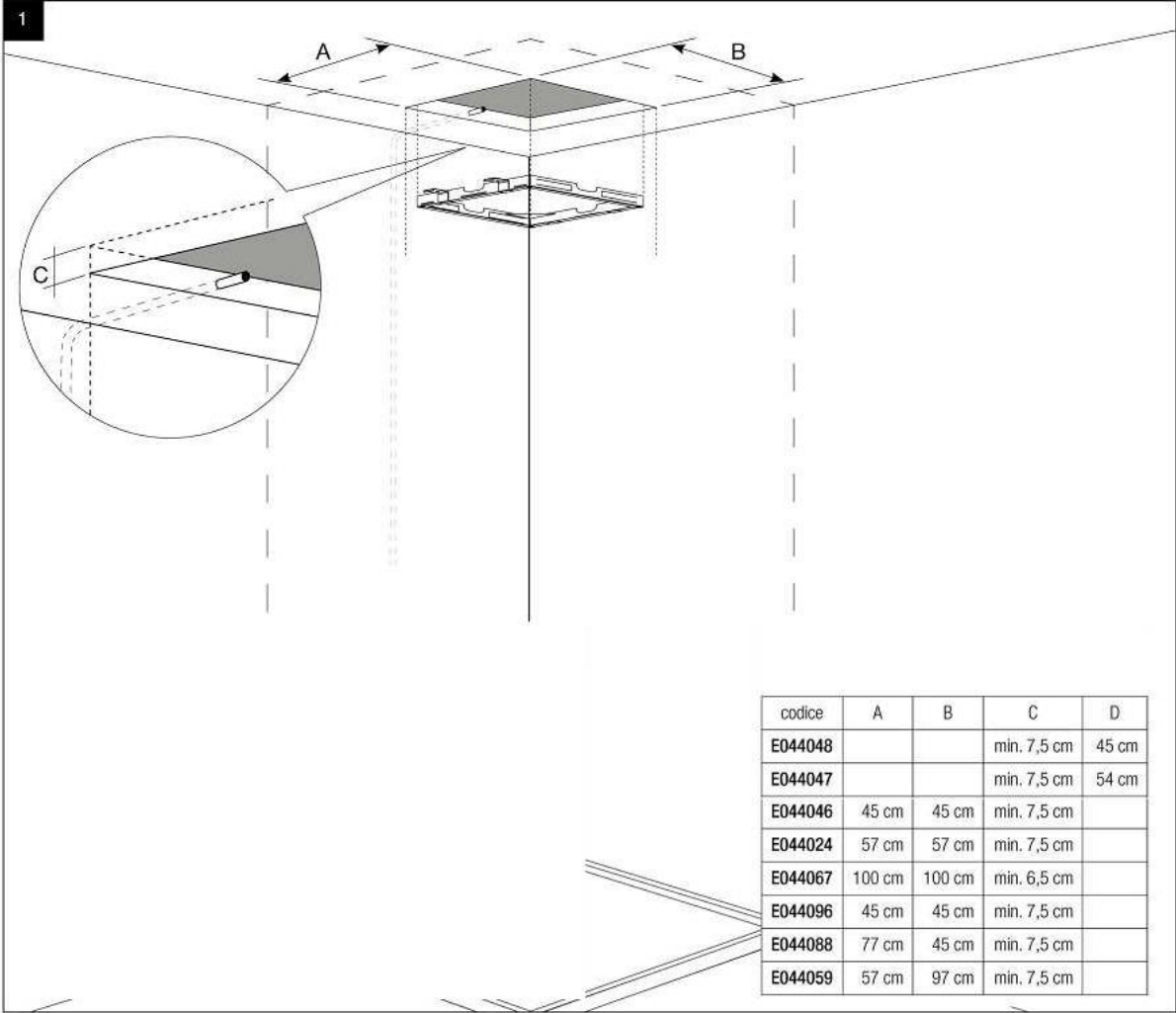

6

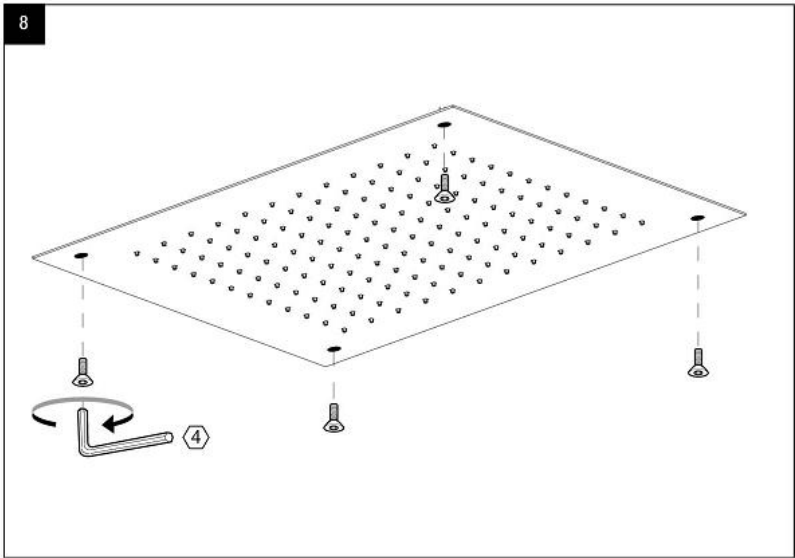
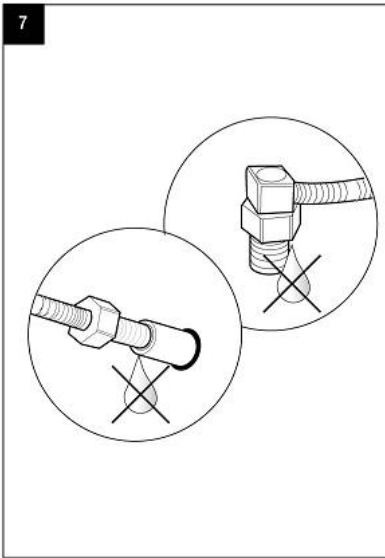
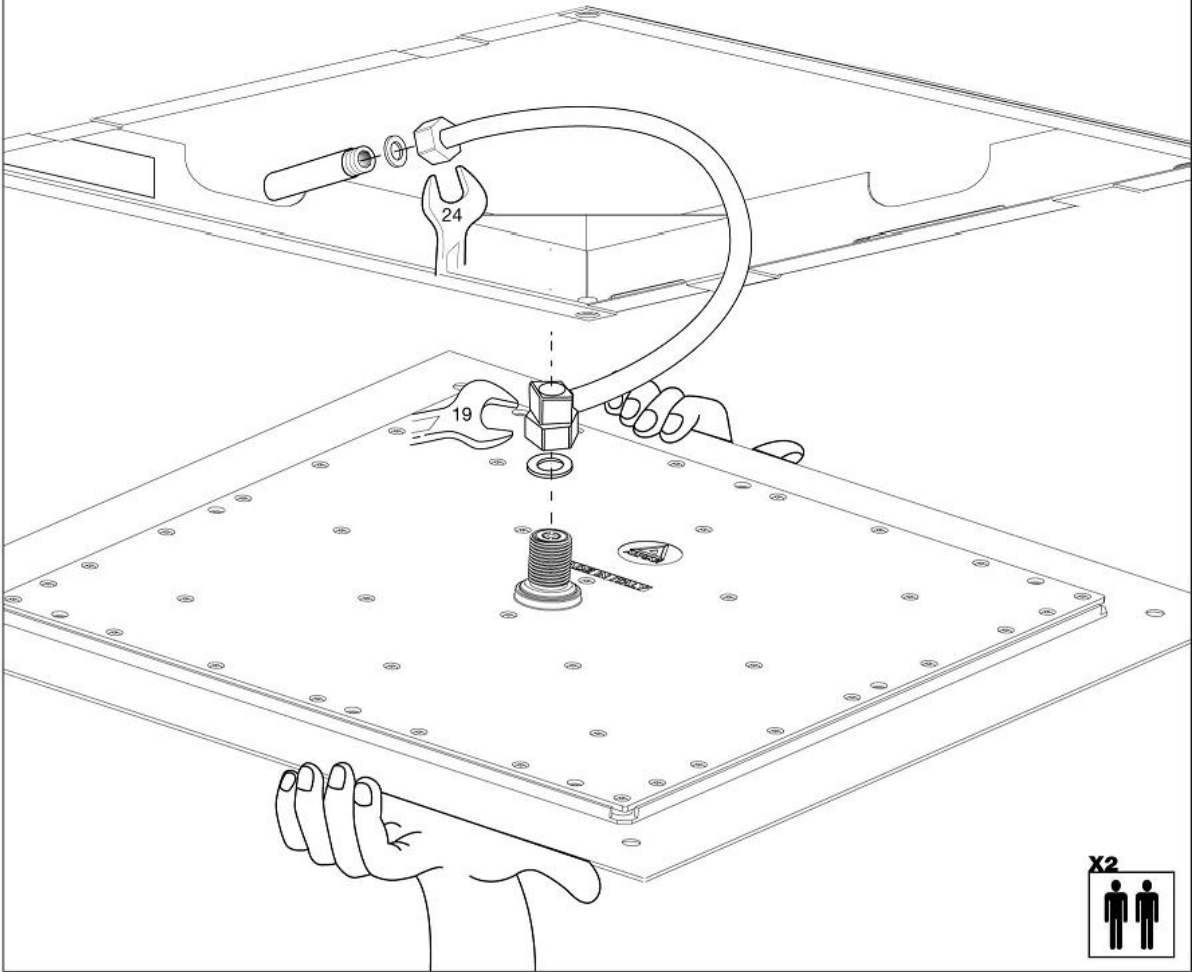



## Cleaning



## Čištění sprchy

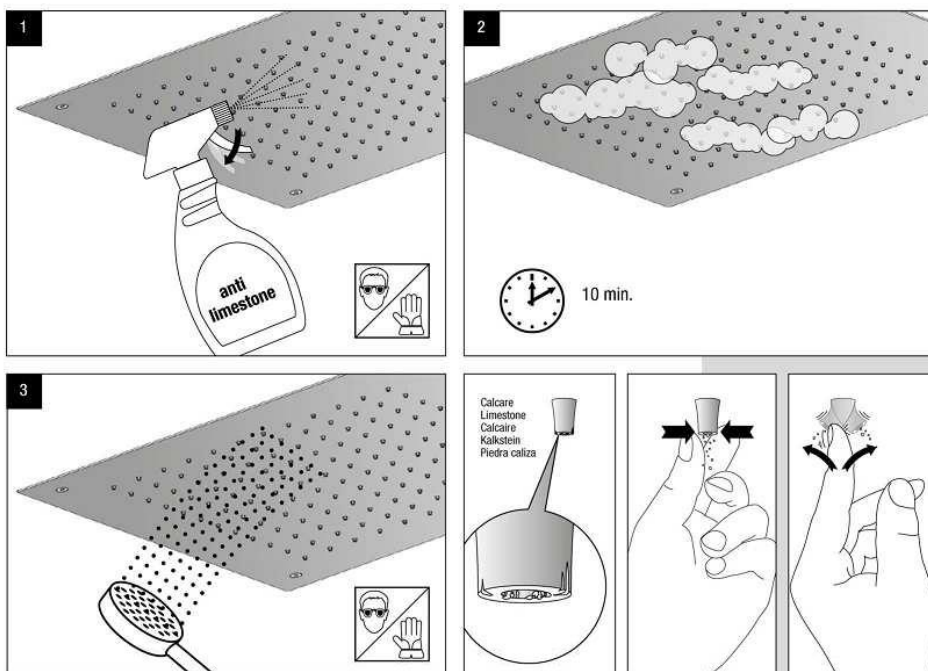

## Optional

## Bezpečnostní sada

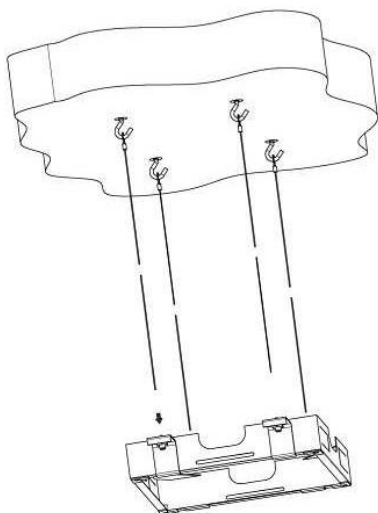

### **DOVOZCE**

**SANJET s.r.o.** , nám. MUDr. J. Svobody 60 , 285 22 Zruč nad Sázavou

tel.: 327 532 298 fax: 327 532 938 mobil: 603 177 127

<http://www.sanjet.cz> , e-mail: [sanjet@sanjet.cz](mailto:sanjet@sanjet.cz)